

Molde

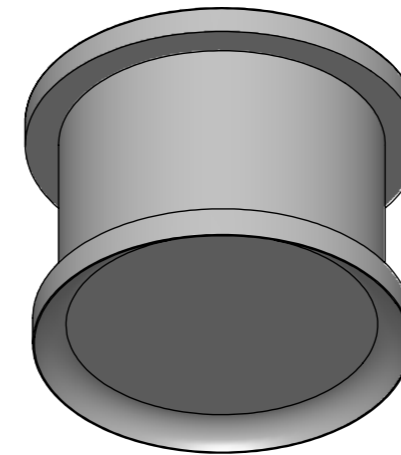

Tapa

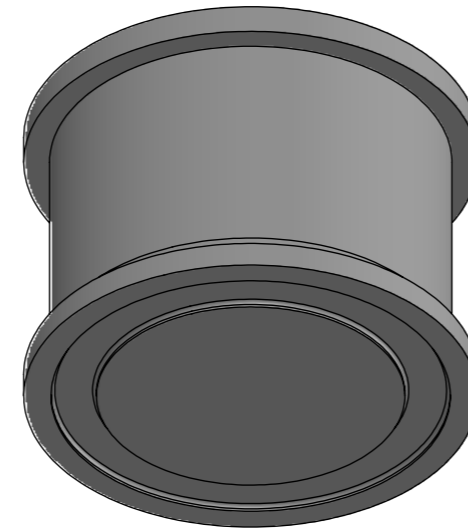
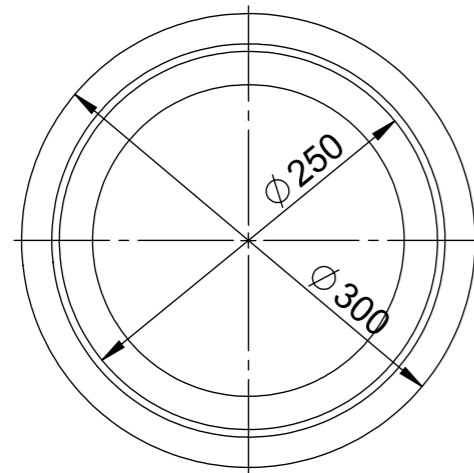
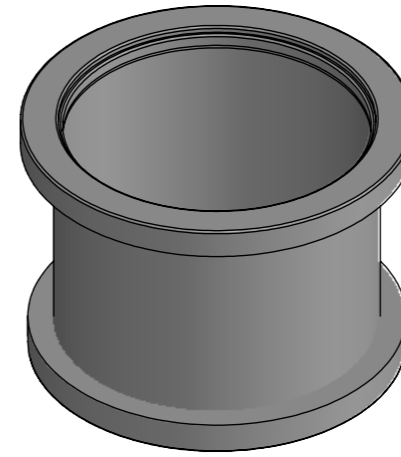
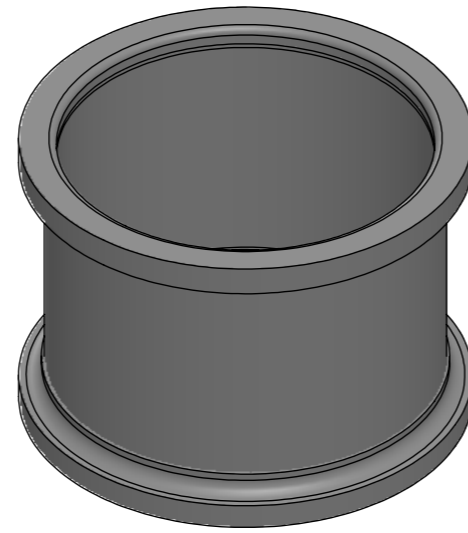
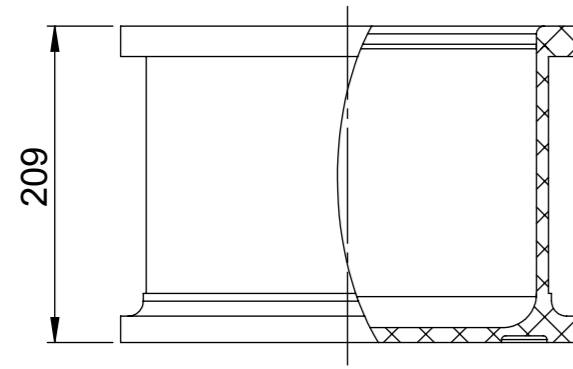
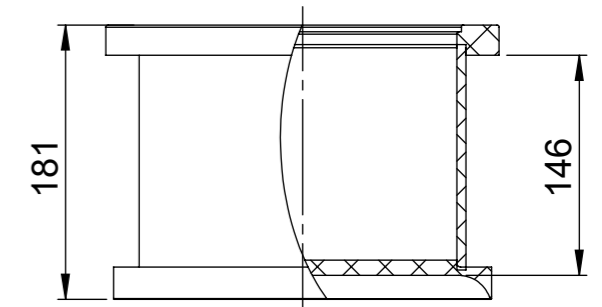
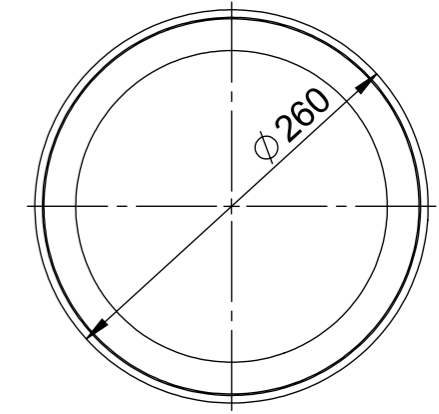

Limite de prensado

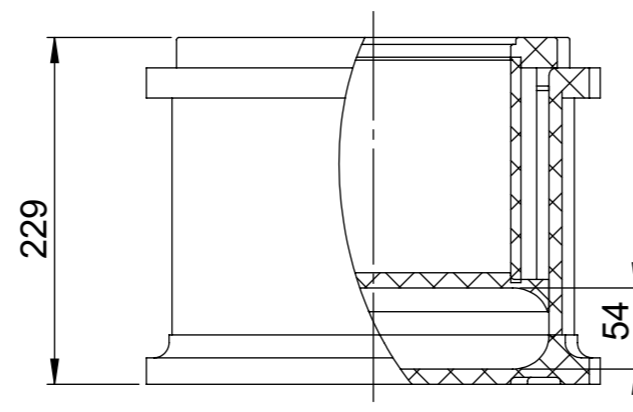

Tolerancias generales			Plano	
Medida nominal inferior	0	300	Molde individual circular (Ø250 x 200) mm	
Medida nominal superior	300	1000	Material	Peso
Tolerancia	±0.5	±1	KUAL-HQ-PE-HD	3,7 kg
Escala	1:5	Denominación		 <small>AGEO CULZONI 2097 RAFAELA-SANTA FE ARGENTINA TE:+549-3492-504060</small>
		Ø250 x H200		
Unidades en mm.		This drawing is our exclusive property and it may not be reproduced, copied or loaned in part or whole, without our written authority.		Este plano es propiedad exclusiva y no debe ser reproducido, copiado o prestado en parte o en su totalidad, sin nuestra autorización escrita.
A3				